

PHLEBOTOMY STATION LAYOUT

2 Station Layout

Installation Instructions:

1. Locate phlebotomy stations as noted in the phlebotomy station layout drawing.
 2. Remove s.s. cap (item 2) and aluminum cover plates (item 3). Mark locations of stations and locations of anchor holes for mounting angles (item 5) on floor.
 3. Move phlebotomy station to install concrete anchors (item 4).
 4. Relocate phlebotomy station back into layout position and install over concrete anchors, leveling station as required with shims, prior to fully tightening down anchor bolts.
 5. Replace s.s. cap (item 2) and aluminum cover plates (item 3).
 6. Seal base perimeter at floor with almond colored silicone sealant.
- * 42" recommended clearance for island or peninsula configuration

Seismic Information:

Work stations meet 2006 International Building Code and 2007 California Building Code requirements (Additional documentation available upon request)

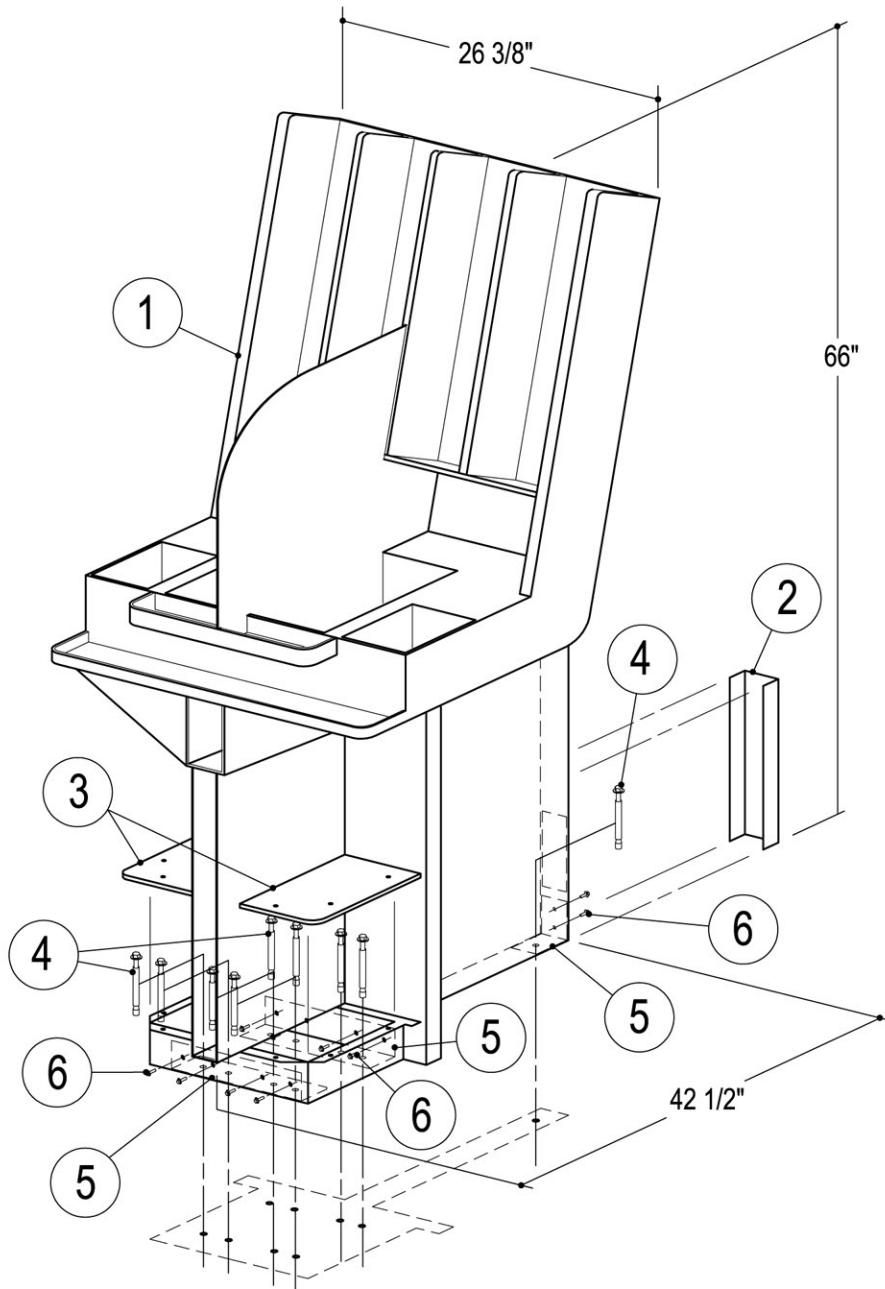

MODEL MMIV - CS CENTRAL PHLEBOTOMY STATION

(WT: 200 lbs.)

PARTS LIST

1. PHLEBOTOMY STATION
2. REMOVABLE S.S. CAP
3. REMOVABLE ALUMINUM COVER PLATES
4. (9) CONCRETE ANCHORS, BY INSTALLER
SIZE AS DETERMINED BY DESIGN SCHEDULE
SHEET 5.
5. (3) MOUNTING ANGLES (LOCATED IN BASE)
6. (6) 3/8" - 16 S.S. TRUSS HEAD SCREWS W/ NU

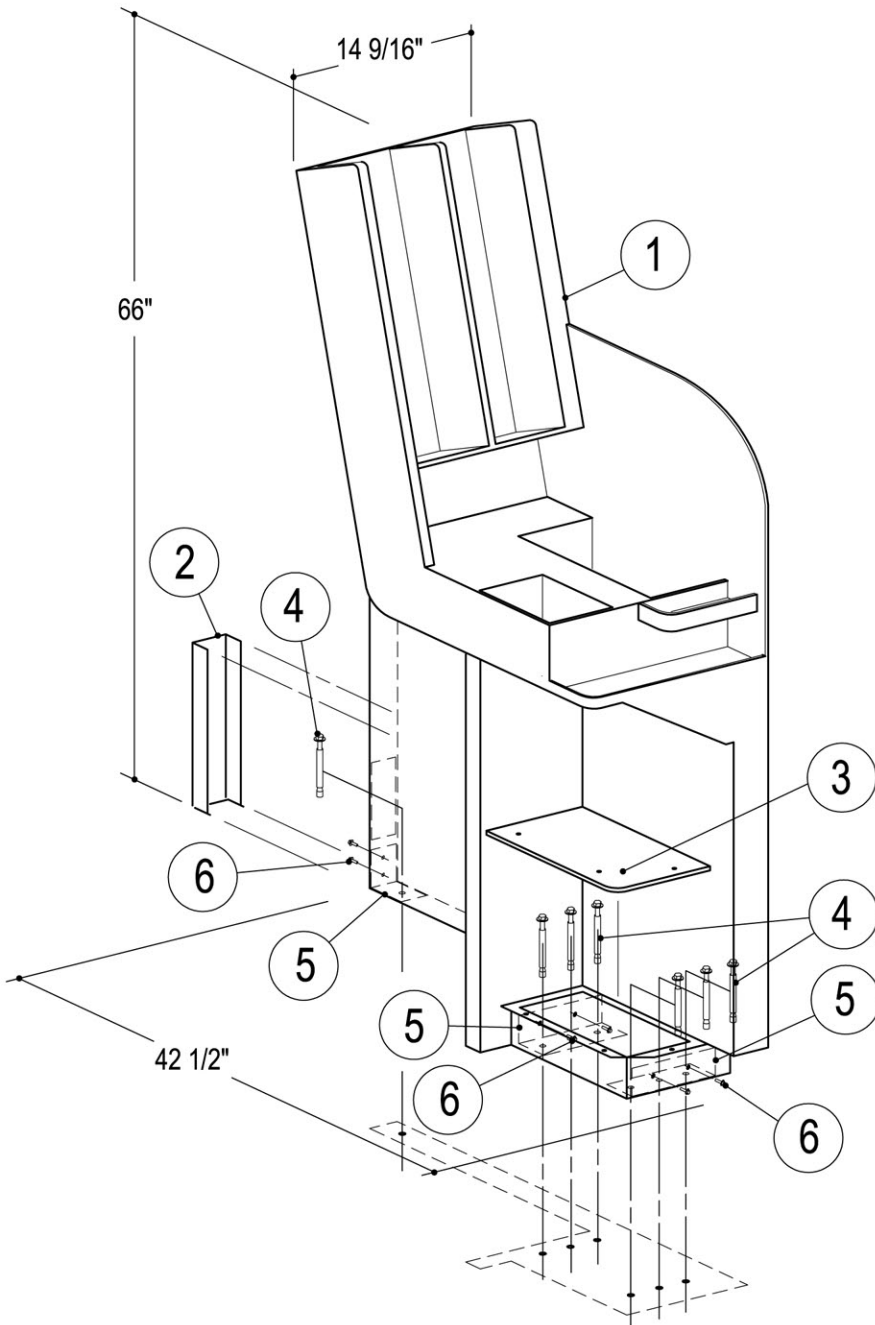

MODEL MMIV - RS RIGHT END PHLEBOTOMY STATION

(WT: 120 lbs.)

PARTS LIST

1. PHLEBOTOMY STATION
2. REMOVABLE S.S. CAP
3. REMOVABLE ALUMINUM COVER PLATE
4. (7) CONCRETE ANCHORS, BY INSTALLER
SIZE AS DETERMINED BY DESIGN SCHEDULE
SHEET 5.
5. (3) MOUNTING ANGLES (LOCATED IN BASE)
6. (6) 3/8" - 16 S.S. TRUSS HEAD SCREWS W/ NUT

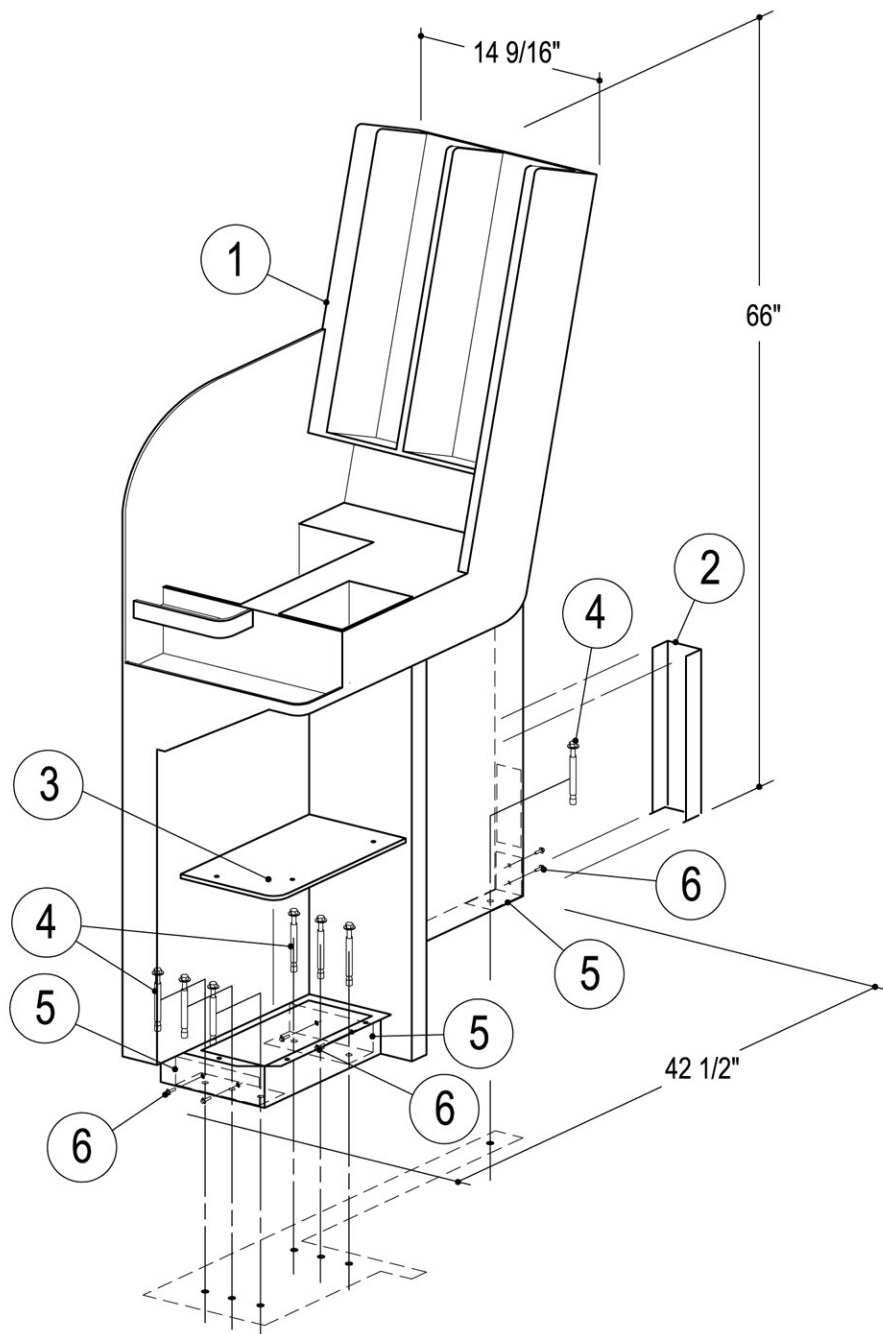

MODEL MMIV - LS LEFT END PHLEBOTOMY STATION

(WT: 120 lbs.)

PARTS LIST

1. PHLEBOTOMY STATION
2. REMOVABLE S.S. CAP
3. REMOVABLE ALUMINUM COVER PLATE
4. (7) CONCRETE ANCHORS, BY INSTALLER
SIZE AS DETERMINED BY DESIGN SCHEDULE
SHEET 5.
5. (3) MOUNTING ANGLES (LOCATED IN BASE)
6. (6) 3/8" - 16 S.S. TRUSS HEAD SCREWS W/ NUT

Design Schedule for Concrete Anchors

Concrete anchors shall be determined by the installer, based on the concrete floor conditions as set by the following criteria. For floor conditions not listed below contact Chaparral for anchor design options.

Concrete Anchor #1

1/2" diameter Hilti KB-TZ wedge anchor with a minimum effective embedment of 3 1/4" in minimum hole depth of 4". To be installed in normal weight or lightweight concrete with minimum concrete strength, f'c, of 3000 psi and minimum concrete thickness of 6"

Concrete Anchor #2

1/2" diameter ASTM A 193 Grade B7 threaded rod in Hilti HIT - RE 500 - SD adhesive with minimum embedment of 2 1/2". To be installed in normal weight or lightweight concrete topping over metal deck where the thickness of concrete topping does not allow for installation of concrete anchor #1.

Notes:

- A. All wedge anchor and epoxy anchor installation shall be continuously special inspected.
- B. All mounting angles are to be attached to the phelbotomy station in the short direction of the station
- C. Contractor to provide separation barrier between dissimilar metals and fasteners