

PLAN
Not to Scale

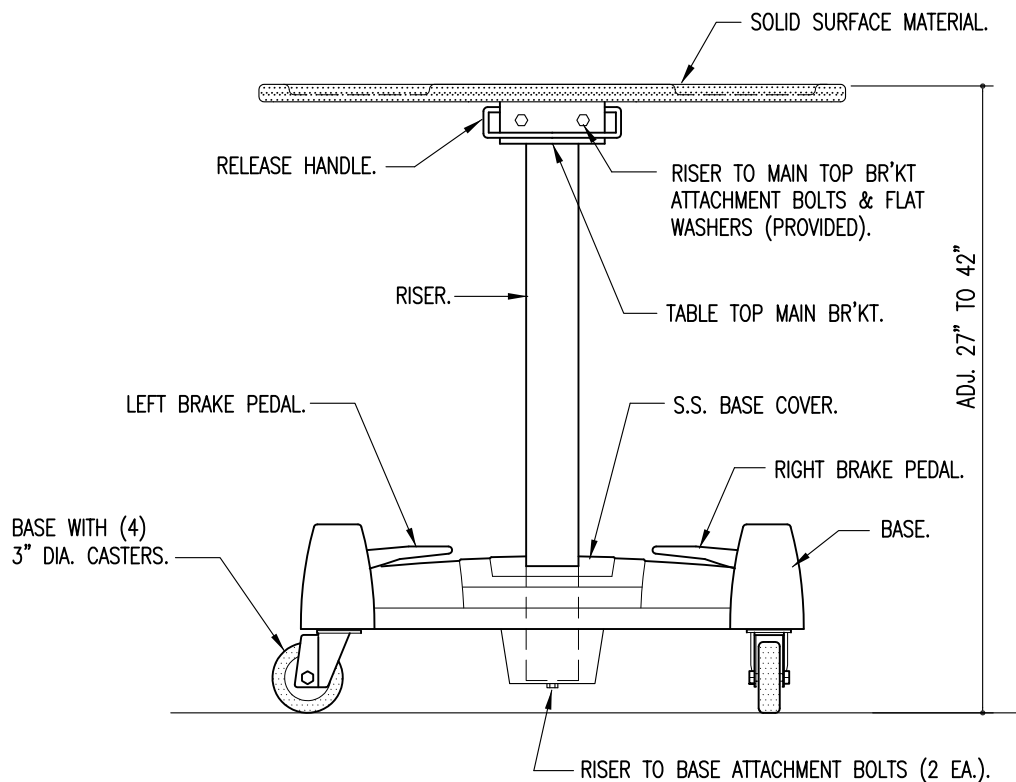

ELEVATION
Not to Scale

This drawing is the property of Chaparral 1 Inc. and is loaned subject to the condition that it is not to be copied, reproduced or distributed either whole or in part and is not to be used directly or indirectly excepting under the supervision of Chaparral 1 Inc.. Nor may it be used in any way that is detrimental to the interests of Chaparral 1 Inc.

Approximate weight: 80 lbs
Approximate Crated weight: 215 lbs



P.O. Box 11368
Portland, OR. 97211 - 0368
Ph: (503) 285-9553
Toll Free Ph: (888) 246-9348
Fax: (503) 285-9526
Toll Free Fax: (877) 246-9526
www.chaparralfixtures.com

Model UN-ADS-DT
Adjustable Draw Stand
Draw Stand w/ Double
Taper Top

Date:
5-6-11

Sheet
1 of 1